

LAMBDA PERISTALTIC PUMP

Revision 12/2025

MANUAL



PRECIFLOW touch

HiFLOW touch

MAXIFLOW touch

MEGAFLOW touch

Software version 5.00 or later.

TABLE OF CONTENT

1.	Technical description	5
1.1	Technical parameters of LAMBDA Peristaltic Pumps	5
1.2	Device description	6
2	Safety.....	7
2.1	Intended use of the pump.....	7
2.2	Use restrictions	7
2.3	Safety for installation, operation, cleaning, maintenance and storage.....	8
3	Guarantee on LAMBDA peristaltic pump	9
4	Power supply connection	10
4.1	Power Supply for remote-controlled pump.....	10
4.2	Power supply for stand-alone pump	10
5	Tubing for LAMBDA Peristaltic Pumps.....	10
5.1	Loading procedure for tubing	11
6	Menu (User Control Logic)	14
6.1	Control method	14
6.2	Remote mode.....	14
6.3	Program library.....	15
6.4	Calibration.....	15
6.5	Settings	15
6.5.1	Common.....	15
6.5.2	Units.....	16
6.5.3	Display.....	16
6.5.4	Sound	16
6.5.5	Programs.....	16
6.5.6	Remote 2 I/O.....	17
6.5.6.1	RS-485 parameters.....	17
6.5.6.2	Input remote	17
6.5.6.3	Master control input.....	18
6.5.7	Fluids name enable.....	18
6.5.8	Device information	19
6.5.9	Restore default	19
7	Direct mode (fixed value).....	20
7.1	Home screen description.....	20
7.2	Dosing screen description.....	20

7.3	Start dosing.....	21
7.4	Stop dosing.....	21
7.5	Change of dosing direction	22
7.6	Maximum.....	22
7.7	Set DIGITAL SPEED	22
7.8	Set FLOW RATE.....	23
7.9	Elapsed dosing time (Delivery time).....	24
7.10	Dispensed volume (Delivery volume)	24
8	Calibration and flow rate volume units.....	25
8.1	Performing calibration	26
9	Program mode (pre-defined program)	28
9.1	HOME screen description.....	28
9.2	Dosing screen description.....	29
9.2.1	program overview	29
9.2.2	Chart view	29
9.3	Select program.....	30
9.4	Edit program.....	30
9.4.1	Edit name	31
9.4.2	Add new segment.....	31
9.4.3	Remove segment	32
9.4.4	Program options.....	32
9.4.4.1	Action on End	33
9.4.4.2	Repeat count	33
9.4.4.3	Units.....	33
9.4.4.4	Calibration.....	34
9.5	Start, pause/restart the dosing program.....	34
9.5.1	Program start.....	34
9.5.2	Program pause.....	35
9.5.2.1	Continue or restart of the dosing program after a pause.....	35
10	Fluids name library	36
11	Software update.....	37
11.1	Software update file.....	37
11.2	PC Software application.....	37
11.3	Update procedure.....	38
12	USB communication.....	41
12.1	Syntax.....	41

12.2	Basic commands.....	41
12.3	Commands with objects.....	42
12.4	response object description.....	43
13	CAN bus communication (REMOTE 1).....	45
13.1	Description of communication.....	45
13.1.1	Extended data frame.....	45
13.1.2	EID bitwise significance.....	47
13.2	Message filtering.....	48
13.3	Commands (Pseudo-identifier).....	49
13.3.1	Read commands.....	51
13.3.2	Write commands.....	52
13.3.3	Data format.....	53
13.4	Heartbeat.....	54
13.5	Connector wiring.....	55
14	REMOTE 2 connector functionality.....	56
14.1	Connector wiring.....	56
14.2	RS Communication protocol.....	56
14.2.1	Format of data sent by the PC to the pump and back.....	56
14.2.2	Commands not containing data.....	57
14.2.3	Checksum control.....	57
14.2.4	Format of the data transmission.....	57
14.2.5	Examples.....	57
15	List of accessories.....	58
16	Revision history.....	59

1. TECHNICAL DESCRIPTION

1.1 TECHNICAL PARAMETERS OF LAMBDA PERISTALTIC PUMPS

	PRECIFLOW	HiFLOW	MAXIFLOW	MEGAFLOW
Type	Microprocessor-controlled programmable laboratory peristaltic pump			
Accuracy	± 5%			
Digital speed	0–1000 rpm	0–2800 rpm	0–3200 rpm	0–3200 rpm
	with 1 rpm			
Flow rate (for maximal tubing diameter)	up to 600 ml/h	up to 3 L/h	up to 10 L/h	up to 60 L/h
	with 0.1 ml/min / 0.1 ml/h steps			
Tubing	Silicone tubing or similar elastic materials (see below)			
Internal memory	Up to 10 dosing programs (100 items per program) & up to 32 fluid names			
Operating pressure	clockwise rotation: approx. 0.1 MPa; counter-clockwise rotation: approx. 0.15 MPa;			approx. 1.8 bar approx. 2.2 bar
Motor	Hybrid Stepper	BLDC 30 W	BLDC 50 W	BLDC 90 W
Gear ratio	9:1	64:1	20:1	20:1
Interface	USB 1.1/2.0, Remote 1 (CAN BUS), Remote 2 (0-10V, RS 485)			
Display	3.5" TFT IPS Display with 320 x 240 pixels resolution Viewing angles: ±70°			
Conformity	DIRECTIVE 2014/35/EU, DIRECTIVE 2014/30/EU			
Technical standards	EN 61010-1:2010/A1:2019/AC:2019-04, EN 61326-1:2013			
Weight	< 1 kg	1.2 kg	1.2 kg	2.5 kg
Dimensions (W x H x D)	104.4 mm x 110 mm x 95 (103.3) mm			180 mm x 127 mm x 160 (169.5) mm
Operating temperature	0 – 40 °C			
Operating humidity	0 – 90%, not condensing			
Power supply	Plug-in power adapter Input Voltage: 90–240 V AC 50/60 Hz, Barrel jack 5.5/2.1			
	12 W 12 V / 1 A	30 W 12 V / 2.5 A	50 W 12 V / 4.16 A	90 W 12 V / 7.5 A

1.2 DEVICE DESCRIPTION

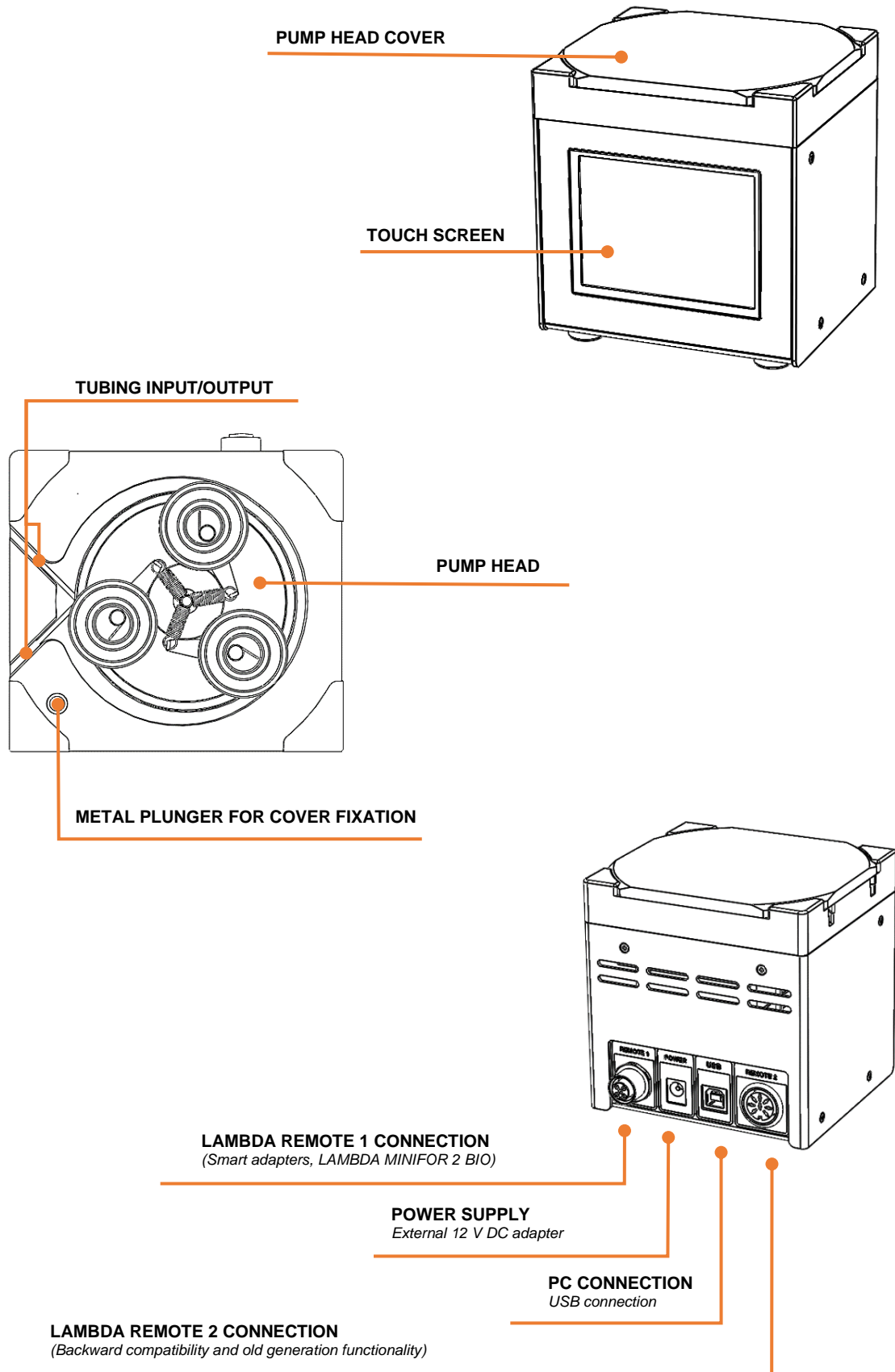

2 SAFETY

Thank you for choosing the LAMBDA peristaltic pump - LAMBDA PRECIFLOW *touch*, HiFLOW *touch*, MAXIFLOW *touch* / MEGAFLOW *touch*. This manual from LAMBDA CZ s.r.o. offers safety information derived from laboratory experience and expertise in designing laboratory instruments.

This user manual provides guidance to the user's safety management team to facilitate the smooth integration of the equipment into their safety protocols. It includes detailed instructions for installation, operation, and safe maintenance of the pump.

The entire manual must be carefully read and fully understood by the user before using the equipment!

The manual's explanations, descriptions, and figures may differ from the scope of delivery due to variations in made-to-order products or recent modifications.

2.1 INTENDED USE OF THE PUMP

The peristaltic pump is designed for laboratory pumping applications, which are usually carried out for industrial and scientific purposes. For proper use it is essential to follow the instructions in this manual.

2.2 USE RESTRICTIONS

- The pump is **not a medical device** and must not be used for medical applications on humans, animals or therapy.
- The pump **must not be used in explosion-proof chambers or in the presence of flammable gases or fumes**. (The gas permeability of pump tubing depends on pressure conditions and the material used. Tubing can become electrostatically charged.)
- The pump must **not be operated outside the designed operating conditions**.
- For **specialized applications** not covered by the conventional, intended use, the equipment must be modified and certified accordingly by the manufacturer.

2.3 SAFETY FOR INSTALLATION, OPERATION, CLEANING, MAINTENANCE AND STORAGE

- › The pump must be installed and used only within the [designed operating conditions](#).
- › Do not cover the ventilation gaps of the peristaltic pump.
- › For safety reasons, the voltage of the external signal must **not exceed 12 V to earth!**
- › Do not grease the tubing holder slots on the pump head!
- › Use only **intact and [recommended tubing](#)**. **Test the selected speed before inserting the tubing** into LAMBDA PRECIFLOW *touch*, HiFLOW *touch* or MAXIFLOW *touch*. For LAMBDA MEGAFLOW *touch*, use the lowest speed during tubing insertion.
- › **Danger by rotating parts:** Be careful not to pinch the fingers when inserting the tubing into the pump head! Do not touch the rotating parts, and ensure that no clothing, gloves, hair, cable or loose objects become entangled!
- › By default, use clockwise rotation **for long-term applications**, which results in lower friction and pressure of the liquid (depending on pump tubing diameter).
- › If higher pressure is required, use counter-clockwise rotation. Do not use counter-clockwise rotation for long-term applications.
- › For long-term use, operate within 0-70% of the maximum pump speed range. Higher pump speeds are intended only for short-term applications.
- › **Tubing** can tear and burst during operation, and the necessary safety measures must be taken based on the specific situation. **If any liquid enters the pump head**, disconnect the pump from the mains before cleaning and servicing.
- › If the pump is **not used for an extended period**, empty the tubing, remove the tubing from the pump head and disconnect the pump from the mains.
- › **Do not open or remove the pump casing** without instructions from LAMBDA CZ s.r.o.!

For service and repairs, contact support@lambda-instruments.com for instructions. Repairs and services can only be carried out by an authorized person who is aware of the hazard involved. LAMBDA CZ s.r.o. assumes no liability for any service or repair performed by the user, an unauthorized person, or third-party companies.

3 GUARANTEE ON LAMBDA PERISTALTIC PUMP

LAMBDA offers a **5-year guarantee** on LAMBDA PRECIFLOW touch, and a **2-year guarantee** on LAMBDA HiFLOW touch, MAXIFLOW touch, and MEGAFLOW touch peristaltic pumps. These guarantees cover proven material and manufacturing defects, provided that the instrument was used following the operational manual and advice given by LAMBDA. Making a warranty claim will not affect the duration of the warranty. Further claims are excluded.

Conditions of guarantee:

- After consulting support@lambda-instrumens.com, the pump must be returned with a comprehensive description of the defect/problem and an authorization number assigned by LAMBDA.
- The customer should dispatch the equipment in its original packaging or packaging of equivalent quality to the LAMBDA service office. Shipping costs to the manufacturer are charged to the customer.
- LAMBDA will not compensate for damage or loss of items during transport.
- Failure to meet these conditions will render the customer ineligible for compensation.

Serial number: _____

Guarantee from: _____

The warranty becomes invalid in the event of improper installation, operation, cleaning, maintenance or storage (for example, outside the intended environmental and/or electrical specifications), in case of damage caused by contaminations or leaks due to torn or burst tubing or unauthorized modification carried out by the user or a third party.

4 POWER SUPPLY CONNECTION

4.1 POWER SUPPLY FOR REMOTE-CONTROLLED PUMP

Do not use any power supply for the *LAMBDA peristaltic pump* if the pump is connected to a bioreactor/fermenter LAMBDA MINIFOR or LAMBDA MINIFOR 2 BIO!

1. Plug the connector of the remote-control cable from the LAMBDA MINIFOR / LAMBDA MINIFOR 2 BIO into the corresponding socket (REMOTE) at the rear of the peristaltic pump.
2. The display will illuminate.

4.2 POWER SUPPLY FOR STAND-ALONE PUMP

1. Plug the power supply connector into the corresponding socket (12 V DC) at the rear of the peristaltic pump.
2. Plug the power supply into the AC mains (90–240 V AC 50/60 Hz).
The display will illuminate, showing the last used settings.

5 TUBING FOR LAMBDA PERISTALTIC PUMPS

For **LAMBDA PRECIFLOW *touch***, **HiFLOW *touch*** and **MAXIFLOW *touch*** peristaltic pumps, use **silicone tubing** with an internal diameter ranging from 0.5 mm to 4 mm and a tubing wall thickness of 1 mm. Pump tubing made of alternative materials with elasticity similar to silicone tubing (shore hardness A 50 - 60) can also be used.

For **LAMBDA MEGAFLOW *touch*** peristaltic pumps, utilize **silicone tubing** with an internal diameter ranging from 2 to 8 mm and a tubing wall thickness of 2 mm.

5.1 LOADING PROCEDURE FOR TUBING

Steps:

1. Remove the cover glass from the pump head:

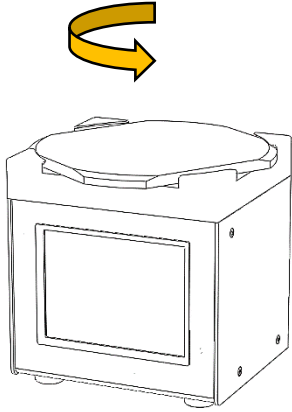

Gently press on the cover glass and rotate it counter-clockwise.

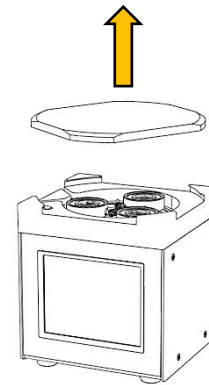

Remove the cover glass in the upward direction.



After removing the cover glass, normal dosing cannot be started. Only the tubing loading process can be activated.

2. Run the load tube process by clicking on “**LOAD TUBE**”. The pump rotor begins to rotate slowly.

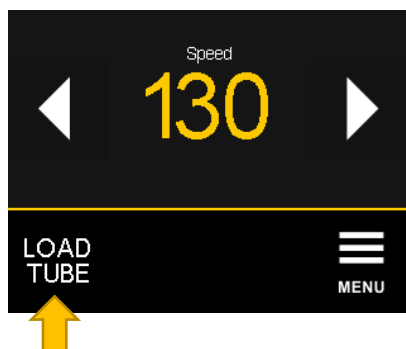

3. Test the selected speed before insertion of tubing into LAMBDA PRECIFLOW *touch*, HiFLOW *touch* or MAXIFLOW *touch*. For LAMBDA MEGAFLOW *touch*, employ the lowest speed when inserting the tubing.

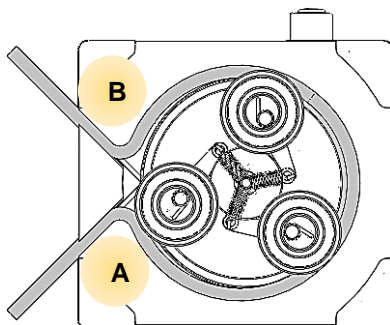
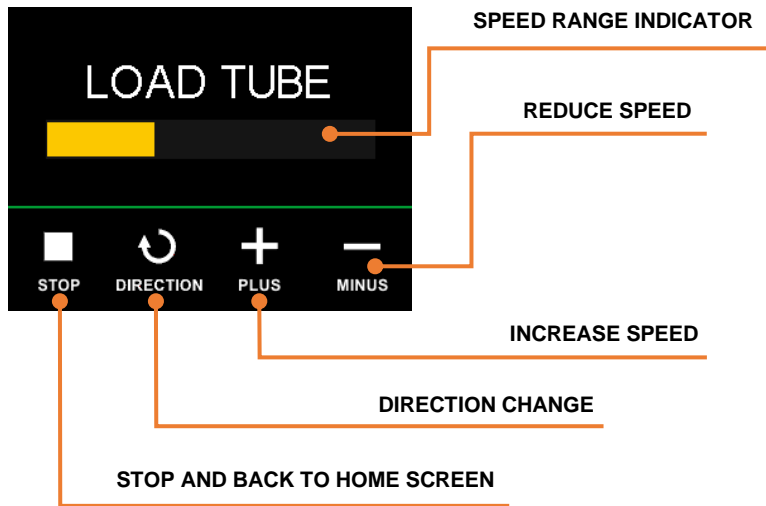

Choose slot A or B, depending on the direction of rotation.

Gradually insert the tubing into the pump head.

Press the tubing to the bottom of the slot when inserting and fixing the pump tubing onto the

pump head. The accurate positioning of the tubing is crucial, particularly with thin pump tubing.

Video for tubing insertion: <https://youtu.be/tilExAMGiXc?t=24>)



4. Apply a small amount of silicone grease to the upper surface of all three plastic bearings that come into contact with the cover glass.

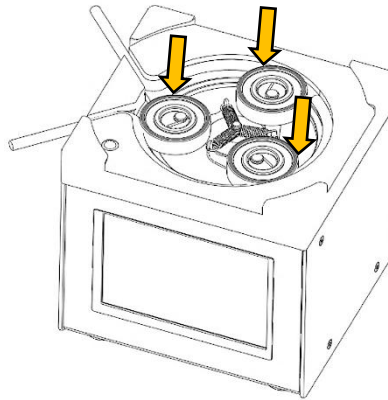

5. Place the cover glass back onto the pump head.

The correct position of the cover glass on the head is marked by a groove into which the metal plunger on the pump head fits.

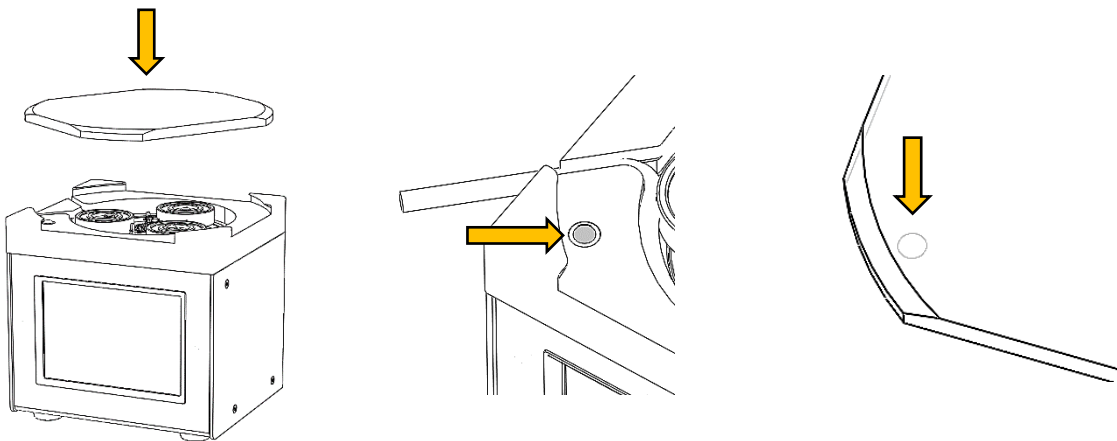

6. Gently press and turn the cover glass back.

The metal plunger will snap into the groove on the cover glass.

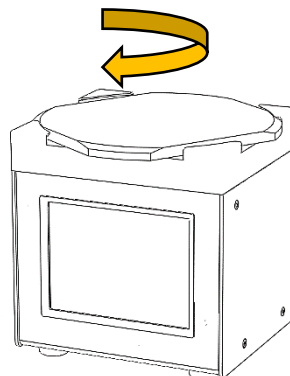

6 MENU (USER CONTROL LOGIC)

The menu is **only available in the STOP state** when dosing is not in progress:

On the main screen in stop mode,

- › Press the icon "MENU".
- › For horizontal navigation between menu items use the "UP" and "DOWN" icons on the right side of the screen.
- › Confirm the selection by clicking on the item

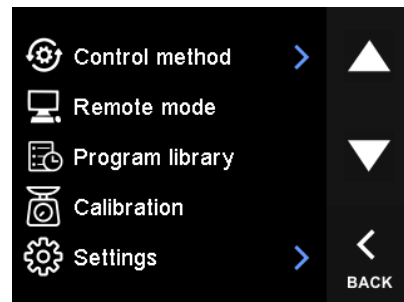

6.1 CONTROL METHOD

The pump is equipped with two dosing control modes:

FIXED VALUE

Fixed value method is used to **dispense a fixed flow rate**, see chapter [“7 Direct mode \(fixed value\)”](#).

PRE-DEFINED PROGRAM

Program mode allows dosing control **at various speeds and durations**. See chapter [“9 Program mode \(pre-defined program\)”](#).

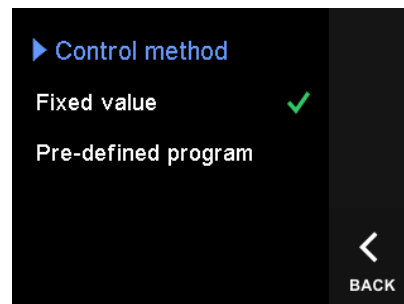

6.2 REMOTE MODE

This item is used for activate REMOTE mode, when the pump is controlled by one of the selected communication interfaces.

For external control of the device it is always necessary to bring it into this mode.

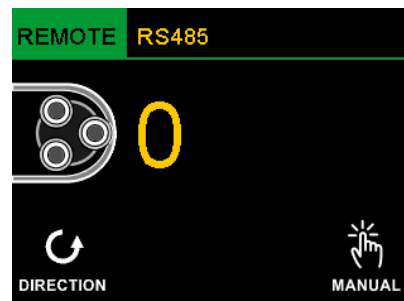

6.3 PROGRAM LIBRARY

The built-in program library allows the creation of 10 programs, where each program can contain up to 100 records.

Use the “UP” and “DOWN” icons to navigate horizontally and change the program. The highlighted program is considered selected for use.

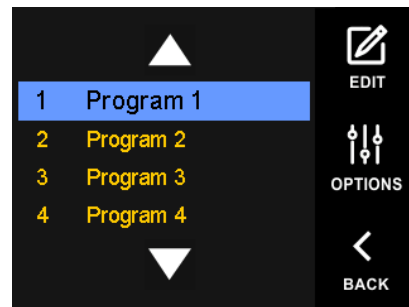

See chapter

[“9 Program mode \(pre-defined program\)”](#).

6.4 CALIBRATION

Enter the calibration environment. See chapter “8. Calibration and flow rate volume units”.

6.5 SETTINGS

Device settings file,

For horizontal navigation between menu items use the "UP" and "DOWN" icons on the right side of the screen.

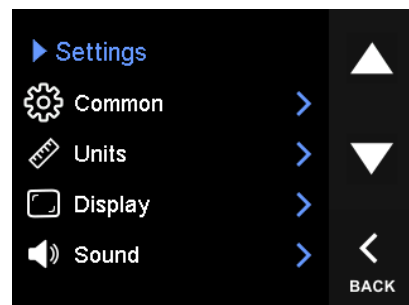

6.5.1 COMMON

› Auto zero when start

If the option is activated, the dosing statistics are automatically reset on restart (RUN).

6.5.2 UNITS

The dosing rate unit can be selected here. The following are available: digital speed, ml/h, ml/min, l/h.

In order to use the instrument in volume units (ml/h, ml/min, l/h), it is necessary to make and set a calibration constant for the tubing used.

6.5.3 DISPLAY

› Backlight intensity

Display backlight intensity setting / range from **1** to **5**

› Touch sensitivity

Adjust the sensitivity of the touch panel display / range from **1** to **5**

6.5.4 SOUND

› Sound volume

Central adjustment of the acoustic alarm volume / range from **0** to **4**
(Level 0 disable acoustic alarm volume)

› Tap sound

Switching the acoustic response on/off when processing a touch on the display

› Alarm sound

Switching on/off the permanent acoustic signalling when an alarm is announced. If enabled, the alarm condition is accompanied by an acoustic signal until cancelled.

6.5.5 PROGRAMS

› **Auto-reset when start**

If the option is active, each new batch run in program mode automatically starts the program from the beginning.

If not active, the display shows the option “Continue or Restart”.

› **Program end alarm**

If the option is active, an “Program finished!” alarm will be issued to complete the program.

6.5.6 REMOTE 2 I/O

The item contains options for configuring REMOTE 2 connector functions and is only available on devices that are equipped with a REMOTE 2 connector.

6.5.6.1 RS-485 PARAMETERS

› **Address**

Communication address of the device, default **2**

› **Data/parity**

Setting the parity data size. Available modes:

8bit (parity none), 8bit (parity even), 8bit (parity odd)

› **Baudrate**

The available baud rates are:

2400 (default), 4800, 9600, 19200, 38400, 57600, 115200

› **Stopbits**

The modes available are: 0 bit, 1 bits, 2 bits

6.5.6.2 INPUT REMOTE

Setting the input remote signal function. This hardware signal is available on the REMOTE 2 connector (for wiring see chapter "[14 REMOTE 2 connector functionality](#)").

- › **Disabled**
The function is disabled
- › **Stop**
Activation of the signal will stop the dosing
- › **Start**
Activation of the signal will start the dosing
- › **Start/stop program**
Activation of the signal starts/stops the program dosing.

6.5.6.3 MASTER CONTROL INPUT

Option to set the main signal to control the dosing rate in REMOTE mode. This setting only applies to REMOTE 2 connector functionality.

- › **0-10V input**
The dosing rate will be controlled by a 0-10V signal
- › **RS-485 commands**
The device will be controlled by RS protocol commands (see chapter "14.2 RS Communication protocol")

6.5.7 FLUIDS NAME ENABLE

Enable/disable the display of the liquid name on the main screen and access to management.

Solution names enables information about the used substance in the tubing to be shown on the display. These names can then be selected manually by clicking on them on the main screen.

(For details about fluids name library, see chapter "[10 Fluids name library](#)".)

6.5.8 DEVICE INFORMATION

View information about the device. Information is available:

Serial number, Software version, Hardware version and Device type.

6.5.9 RESTORE DEFAULT

This option is used to reset the menu items to their default state.

7 DIRECT MODE (FIXED VALUE)

Direct mode is a mode in which the speed is controlled by a fixed value.

7.1 HOME SCREEN DESCRIPTION

The home screen is always displayed when the pump is idle. The parameter setting is done by clicking on the value. Changing the parameter type is done by clicking the right or left arrow icon.

Home screen in DIRECT mode (See also chapter “6.1 Control method”).

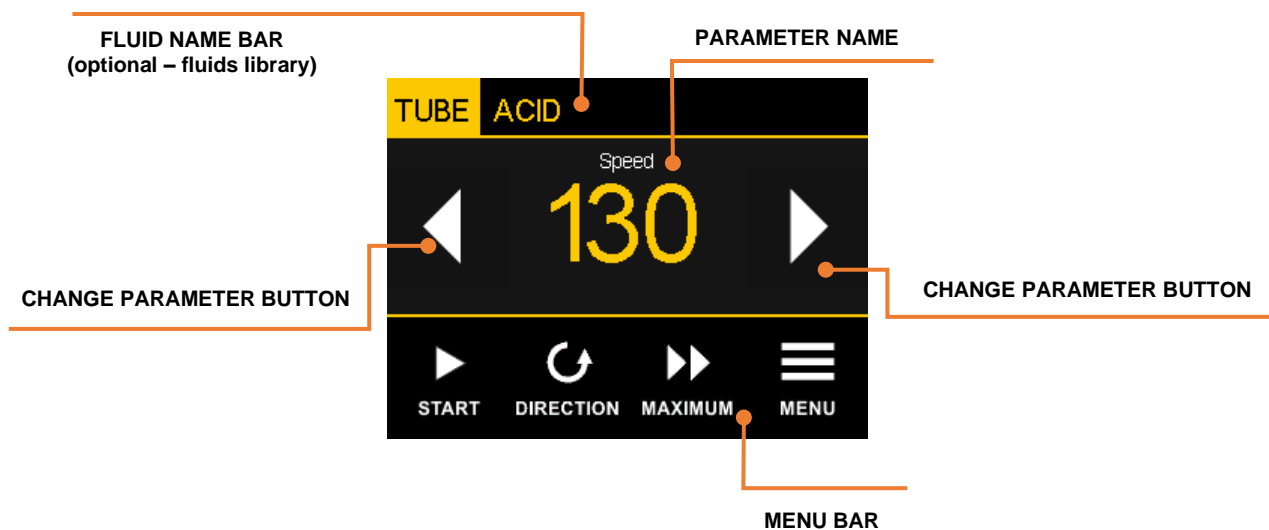

7.2 DOSING SCREEN DESCRIPTION

During dosing, the dosing screen is displayed with information about the flow rate and elapsed dosing time.

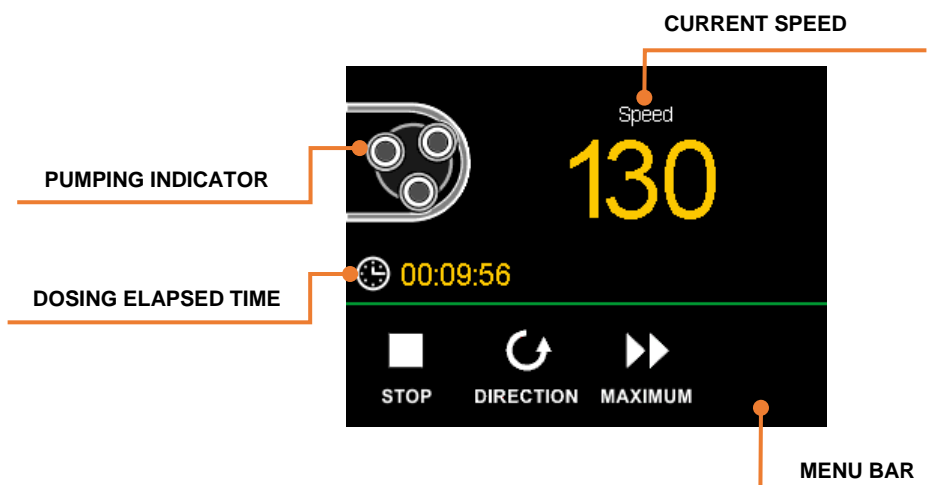



If volume units are selected in the settings, calibration is performed (calibration constant is set), the dosing rate is automatically displayed as **flow rate** instead of **speed**. In addition, information (counter) about the dispensed volume is automatically available.

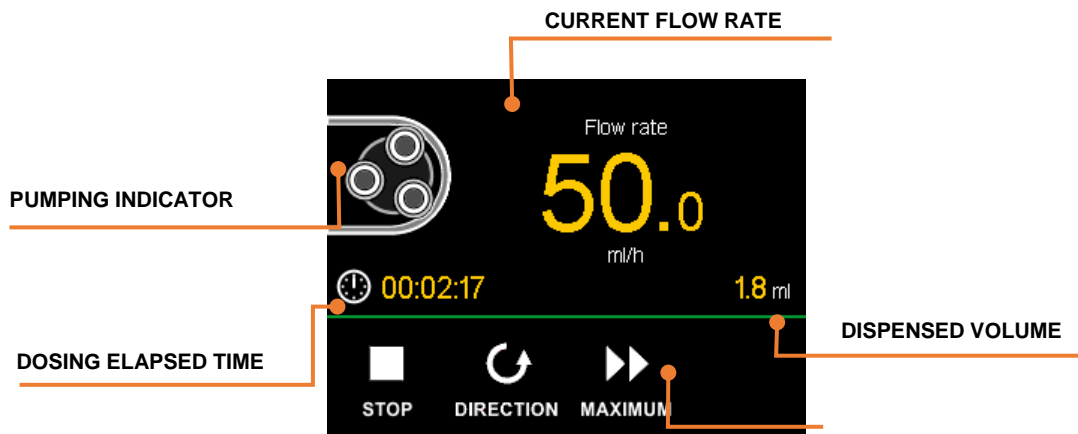

7.3 START DOSING

On the main screen,

- dosing is started by clicking on the "**START**" icon.

After clicking, dosing starts at the set rate and the dosing screen appears on the display.

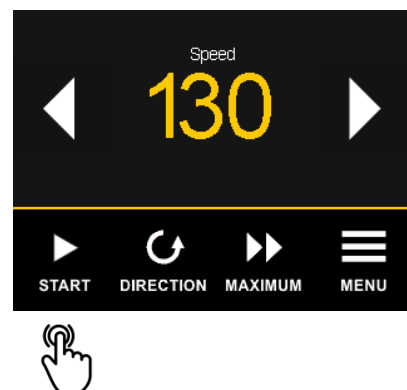

7.4 STOP DOSING

On the dosing screen,

- dosing is stopped by clicking on the "**STOP**" icon.

After clicking, the dosing is finished, and the main screen will appear on the screen.

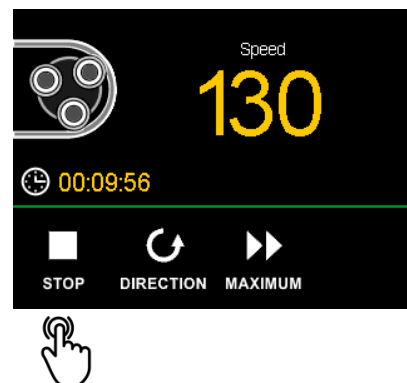

7.5 CHANGE OF DOSING DIRECTION

The arrow icon shows the currently selected direction of rotation of the pump head rotor.

- Changing the flow direction is done by clicking the "DIRECTION" icon.

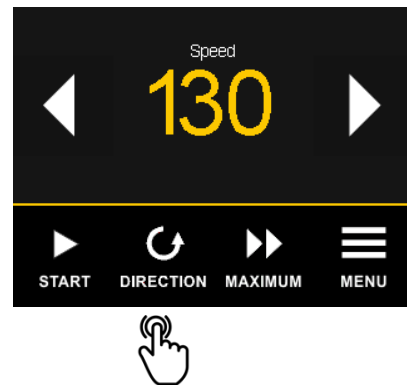

7.6 MAXIMUM

- Dosing at maximum speed starts by clicking and then holding the "MAXIMUM" icon.

After release, the previous speed is applied. (If the pump was previously stopped, then the dosing is interrupted.)

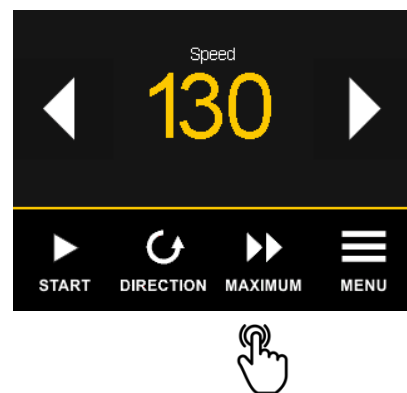

7.7 SET DIGITAL SPEED



Available when digital speed units are selected.

The digital speed can be changed during pumping with DIRECT flow control.

To set the digital speed click on the **speed parameter** on the **main screen**.



The individual flow rate digits will be displayed on the screen.

- Use the up or down arrows to set the desired value.
- Confirm the new value by clicking the "SET" button, or go back and ignore the change by clicking the "BACK" button.

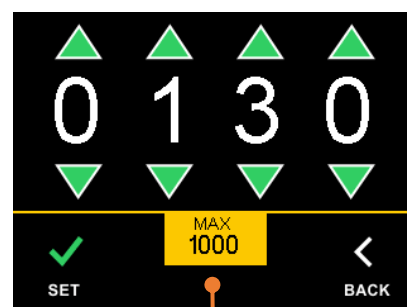

MAXIMAL FLOW RATE INDICATOR

7.8 SET FLOW RATE



Available when volume units (ml/h, ml/min or l/h) are selected.

The flow rate can be changed during pumping with DIRECT flow control. To set the flow rate click on the **flow rate parameter** on the **main screen**.

MAXIMAL FLOW RATE INDICATOR

The individual flow rate digits will be displayed on the screen.

- Use the keyboard to set the value
- To delete the whole value click on "**CLEAR**"
- Confirm the new value by clicking the "**SET**" button, or go back and ignore the change by clicking the "**BACK**" button.



7.9 ELAPSED DOSING TIME (DELIVERY TIME)

The duration of elapsed dosing time is available as “**Delivery time**” on the main screen by clicking the right or left arrow icon.

- A value is **reset** by clicking on the value.
- A confirmation of the reset value will appear on the screen.

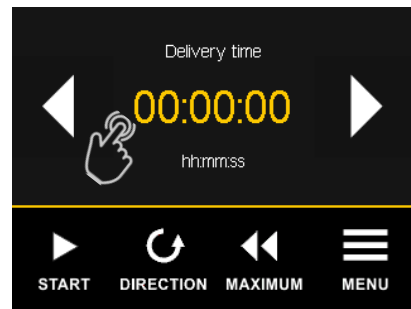

7.10 DISPENSED VOLUME (DELIVERY VOLUME)

Dispensing volume (Delivery volume) is available only when volume units are set and [calibration](#) is performed!

The amount of dispensed volume is available as “**Delivery volume**” on the main screen by clicking on the right or left arrow icon.

- **Reset** is done by clicking on the value.
- A confirmation of the reset value will appear on the screen.

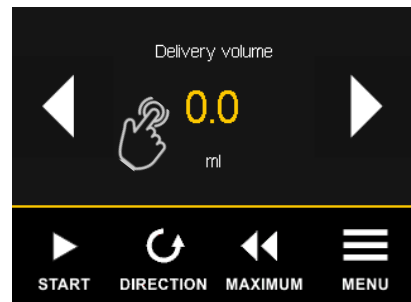

8 CALIBRATION AND FLOW RATE VOLUME UNITS

A Calibration is necessary to convert and directly set the flow rate. During calibration the amount of liquid the pump dispenses during a set time is measured. It is best to use a **laboratory scale** to measure the amount of liquid. The balance/scale must be adjusted according to the desired accuracy range. The calibration process uses a medium dosing rate and **takes one minute**.

Before calibrating the pump flow rate, ensure the liquid **completely fills the pump tubing** and reaches its free end.

See chapter “6.5.2 Units” for setting volume units for flow rates.

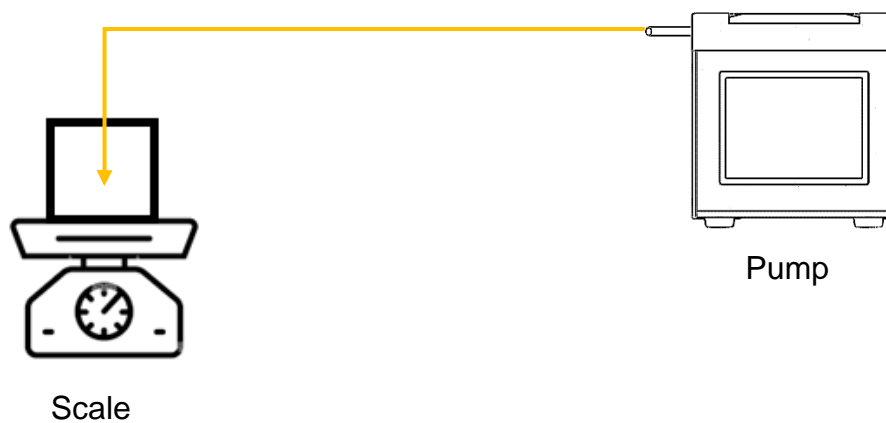

8.1 PERFORMING CALIBRATION

Go to calibration by clicking the "**CALIBRATION**" item in main menu.

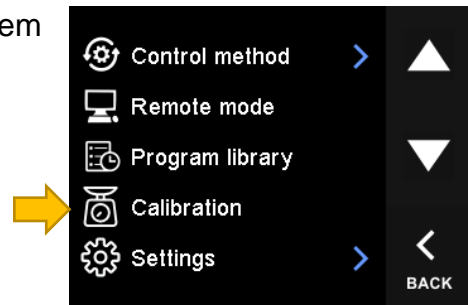

Prepare to measure the amount of liquid dispensed. (See the illustration above as an example of measurement with scale.)

Steps:

1. Check the rotation direction of the pump head rotor so that the dosing occurs in the direction of the laboratory balance or other measuring device.

You can change the flow direction by clicking the "**DIRECTION**" icon.

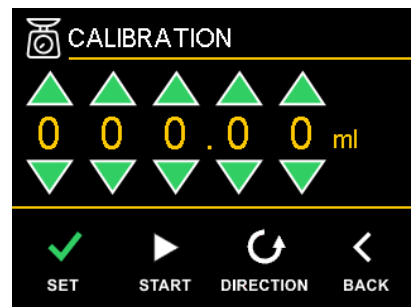

2. After preparation of the measuring device, start the calibration (dosing) by clicking on the "**START**" icon.

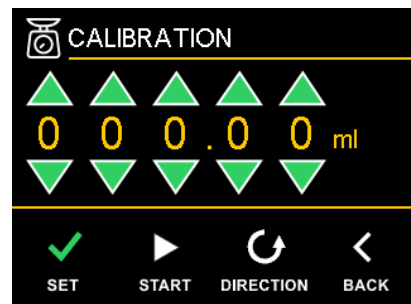

3. CALIBRATION IN PROCESS

Wait for calibration (dosing) to complete.

After the calibration time has elapsed, the pump will automatically stop and return to the calibration screen.



4. CALIBRATION

Enter the **dispensed volume**:

Click the up and down arrow icons to enter the dispensed volume value in milliliters (measured).

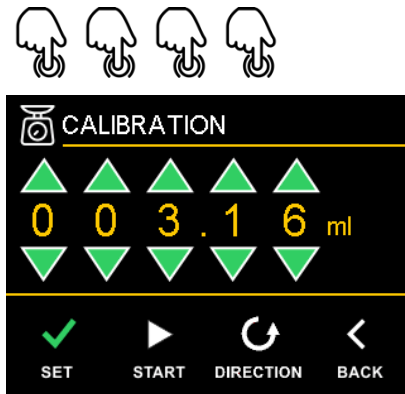

9 PROGRAM MODE (PRE-DEFINED PROGRAM)

For use in program mode it is necessary to activate the **control method** in the menu on **pre-defined program**.

Program structure:

<i>Name</i>	Name of program
<i>Segments</i>	Segment (defined by flow rate/speed, time length, type of transition, and dosing direction)
<i>Action on End</i>	Selection of program end by stop (invoke alarm), continue with last speed/flow rate or repeat from start
<i>Count</i>	Number of program repetitions
<i>Units</i>	Units for defining the flow rate
<i>Calibration</i>	Calibration constant for volume units



Completion of the program is indicated by the "Program finished!" alarm. Valid for action on end "stop" or "repeat" with defined repetition.

9.1 HOME SCREEN DESCRIPTION

Home screen in DIRECT mode (See also chapter [“6.1 Control method”](#)).

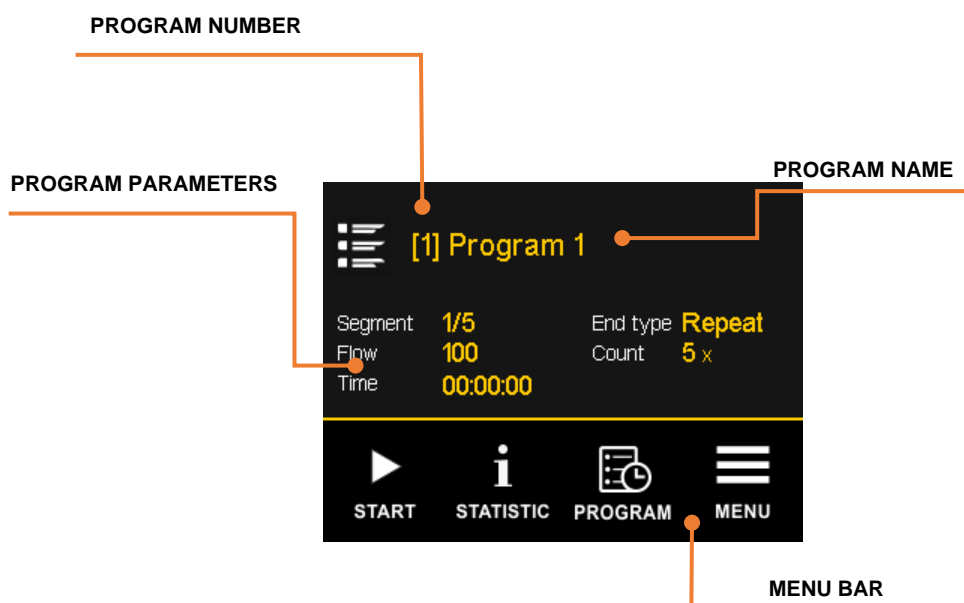

9.2 DOSING SCREEN DESCRIPTION

After starting the dosing, the dosing screen will appear on the display.

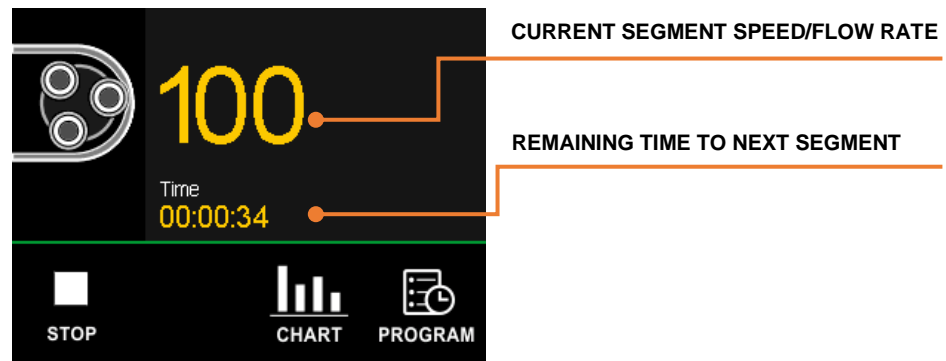

9.2.1 PROGRAM OVERVIEW

During the program processing, it is possible to display the program's current parameters. The display can be called up by clicking the "**PROGRAM**" icon on the dosing screen in program mode.

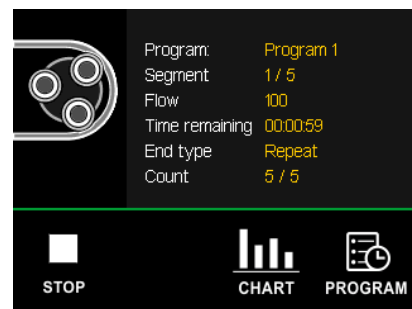

9.2.2 CHART VIEW

It is possible to display the progress of program processing in a graph.

The program processing is represented by a gradually filling area of the graph. The different fill color symbolizes the dosing direction (**DIRECTION**).

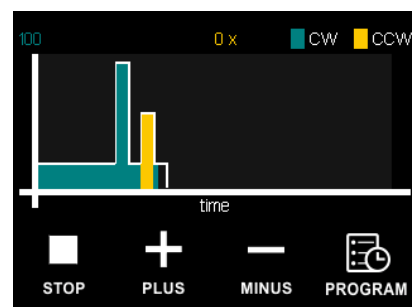

By clicking the **+** or **-** icon, it is possible to change the timescale.

9.3 SELECT PROGRAM

Changing or selecting the program is only possible when the pump is stopped, idle.

Steps:

1. Go to the program library by clicking on the **Program** icon on the main screen or by clicking on **Program library** in the menu.

On the **PROGRAMS** screen, the currently selected program is the highlighted row of the table.

1. Click the up and down arrow icons to **change the program**.
2. Click the "**BACK**" icon to **return to the main screen**.

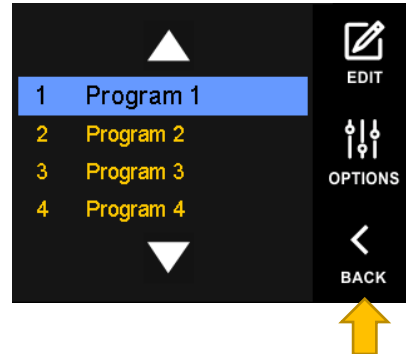

Changing the program is done automatically by selection. The newly selected program is automatically applied by closing the program library by clicking on "**BACK**".

9.4 EDIT PROGRAM

Steps:

2. Go to the program library by clicking on the **Program** icon on the main screen or by clicking on **Program library** in the menu.

On the **Program library** screen, the currently selected program is the highlighted row of the table.

3. Click the up and down arrow icons to **select the requested program** to edit.
4. Click the "**EDIT**" icon to go to the program edit screen.

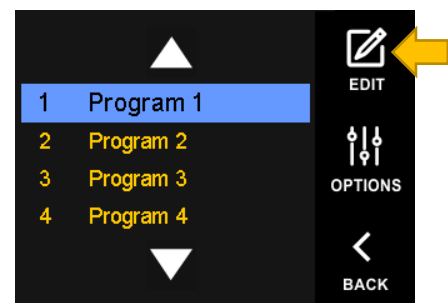

9.4.1 EDIT NAME

Click in the **program name area** to change it. The screen will show the current name with an alphanumeric keyboard. Confirm the change by clicking the "OK" button.

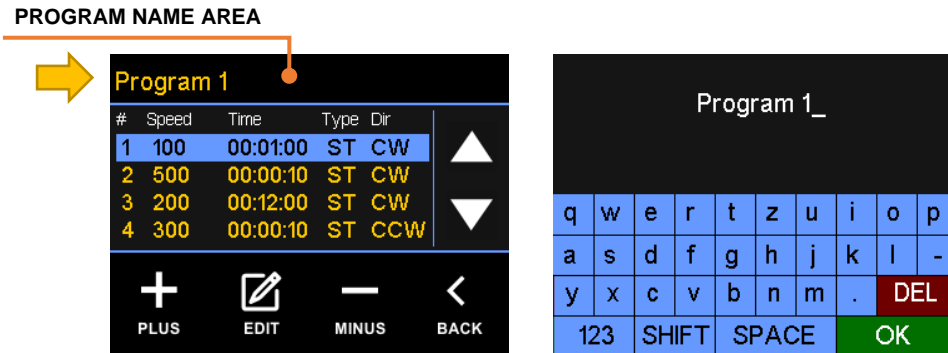

9.4.2 ADD NEW SEGMENT

1. Click on the "PLUS" icon to add a new program segment.

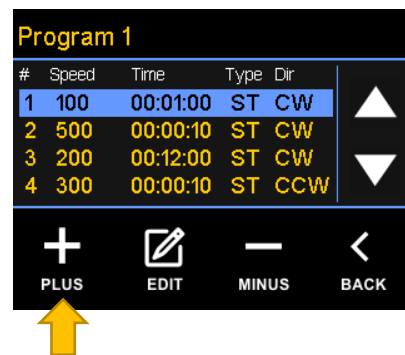

2. Enter the program segment parameters:
You can call up the settings of individual parameters by clicking on the parameter value.

SPEED/FLOW RATE: requested speed/flow rate

TIME: requested time length of set speed/flow rate

TYPE: transition type (STEP or RAMP)

DIRECTION: CW or CCW

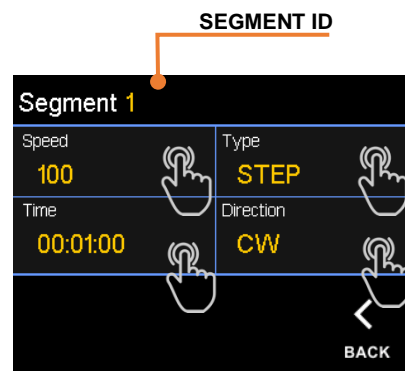

The speed/flow rate transition type has two setting options. **STEP** means that the value will be set immediately. **RAMP** means that the desired value is the target value and will be approximated for the set time length.

3. Click the "BACK" icon to return to the program edit screen.

9.4.3 REMOVE SEGMENT

1. Select the segment you want to remove (highlighted table row) by clicking the up and down arrow icons.
2. Click the "**MINUS**" icon to remove a currently highlighted program segment.

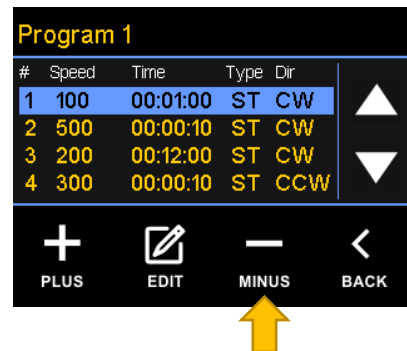

9.4.4 PROGRAM OPTIONS

Each program has its own specific global settings such as action on end, repeat count, program units and calibration constant.

The program includes setting options: [Action on End](#), [Repeat Count](#), and [Flow rate units](#).

Click on the "**OPTIONS**" icon to view the program settings.

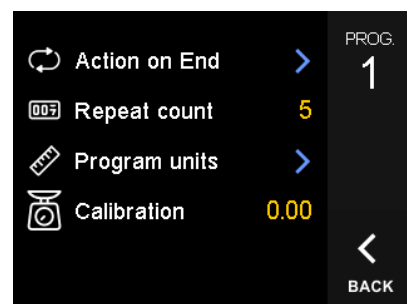
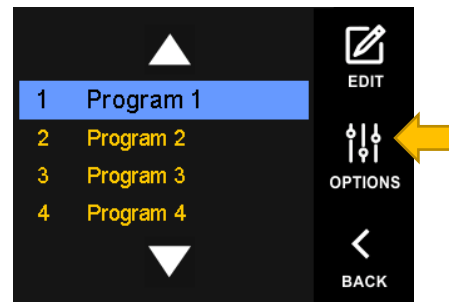

9.4.4.1 ACTION ON END

Choose what action shall take place to process all program segments:

REPEAT PROGRAM:

The program will be processed again from the first segment. The number of repetitions can be set.

CONTINUE:

After completion of the last segment of the program, dosing will continue with the last set speed/flow rate value.

STOP PROGRAM:

Dosing will be terminated when the last segment of the program is completed and invoke alarm **“Program finished!”**.

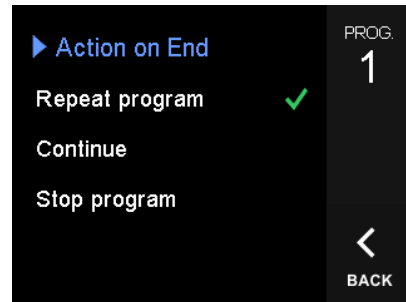

9.4.4.2 REPEAT COUNT

This parameter will only be used if action on end is set to repeat.

Choose the number of program repetitions.

A value of 0 means infinite repetition!

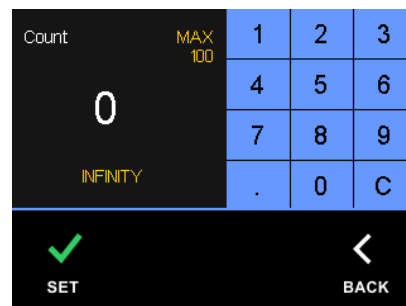

9.4.4.3 UNITS

Setting the speed or flow rate units for the values listed in individual segments of the program.

If volume units are selected, it is also necessary to set the calibration constant (chapter 9.4.4.4 Calibration).

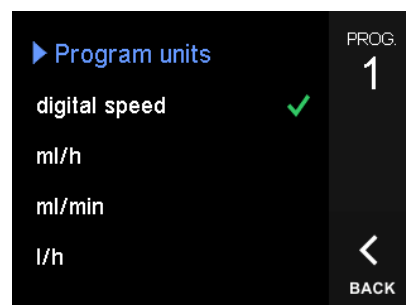

9.4.4.4 CALIBRATION

To use volumetric units, a conversion calibration constant must be set. The constant for the type of tubing used is obtained by calibration, see chapter

Enter the calibration constant,
click "**SET**" to confirm the new value or
"**BACK**" to return to the last saved value.

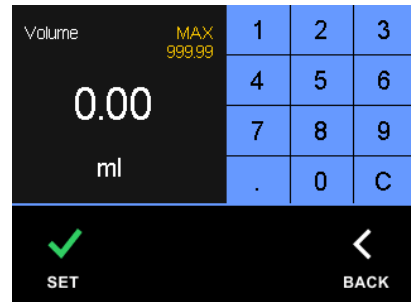

9.5 START, PAUSE/RESTART THE DOSING PROGRAM

To use programs, it is necessary to activate **FLOW CONTROL** in the device menu to **PROGRAM** mode.

9.5.1 PROGRAM START

For starting the dosing by the dosing program, click on "START", on the pump display.

The dosing program is running.

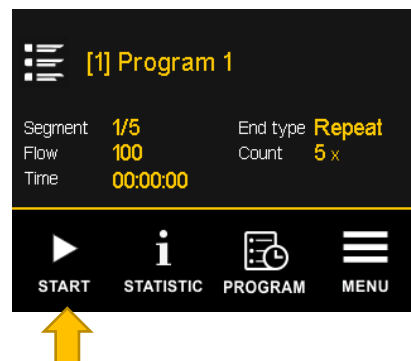

9.5.2 PROGRAM PAUSE

For interruption/pause of the dosing program, click on "STOP", on the pump display.

The dosing / dosing program is interrupted.

9.5.2.1 CONTINUE OR RESTART OF THE DOSING PROGRAM AFTER A PAUSE

To finish the pause, click on "START", on the pump display.

The pump display shows "Continue or Restart ?"

- Click "**CONTINUE**" to resume the program from where it stopped = continue the program.

OR

- Click "**RESTART**" for running the program from the beginning (First step 1 of program, t = 0) = restart the program

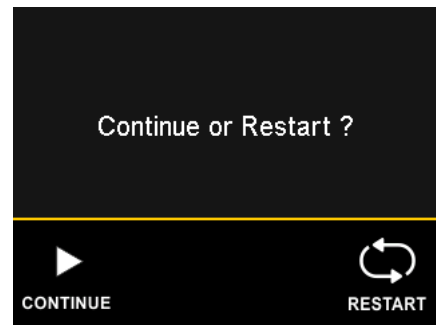

The automatic restart of the program can be set in the main menu, settings item. See options in chapter "6.5.5 Programs".

If the automatic restart is not active, the user is prompted for a decision with each new start of dosing.

10 FLUIDS NAME LIBRARY

The pump has an integrated library of fluid names that the user can display. It is used to quickly find out what preparation the pump is dispensing.

The library items can be edited from a PC via the *LAMBDA Device Manager* software application.

The number of items is limited to 32.

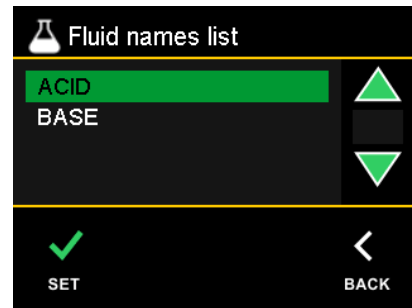

11 SOFTWARE UPDATE

11.1 SOFTWARE UPDATE FILE

First, download the pump software update file to your PC from the manufacturer's website. The file is compressed, tagged and has a fixed format (pump-1-X.YY.zip).

Steps:

1. Download the archive “**pump-2-x.yy.zip**” file.
2. Decompress archive containing pump software file “**pump-2-x.yy.hex**”

11.2 PC SOFTWARE APPLICATION

The PC software application *LAMBDA Device Manager* (Idm) is available for pump software updates.

Steps:

3. Download “**Idm-x.y-x64-setup.exe**” file (X, Y subsites version number)
4. Run the downloaded installation file.
5. Finish the installation of the application.

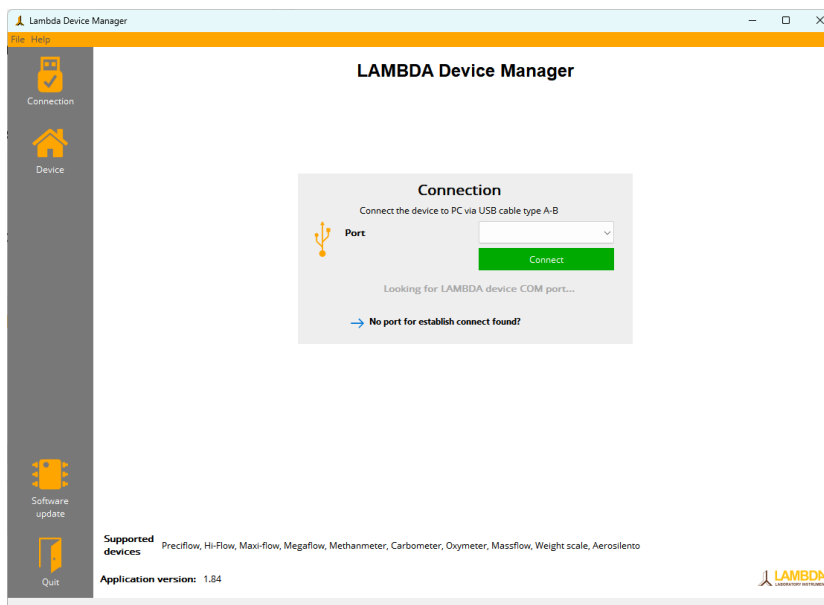

11.3 UPDATE PROCEDURE

Follow these steps to update:

1. Connect the supplied 12V DC power adapter to the pump.
2. Connect the pump to the PC using the A-B USB cable.
3. Start the *Lambda Device Manager* application.
4. Wait and check that the computer has detected the pump.

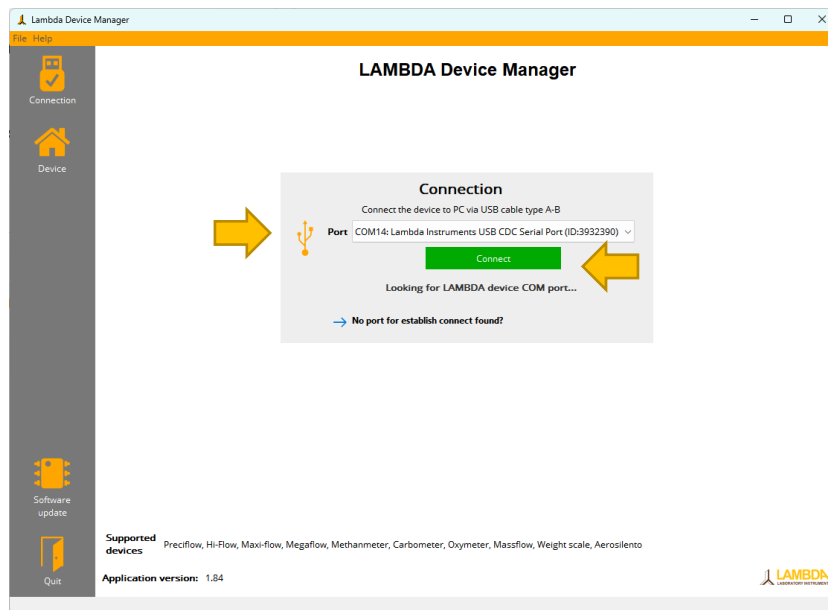

Example: Detected **port** COM14, pump with identification number 3932333.

5. Click on the “Connect” button.

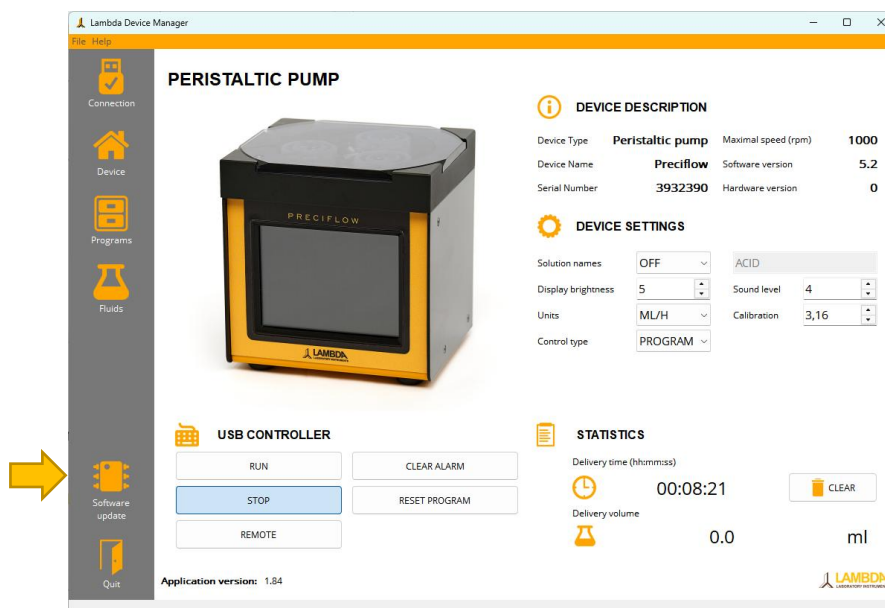

6. Select the “**Software Update**” function on the left bottom side of the panel.

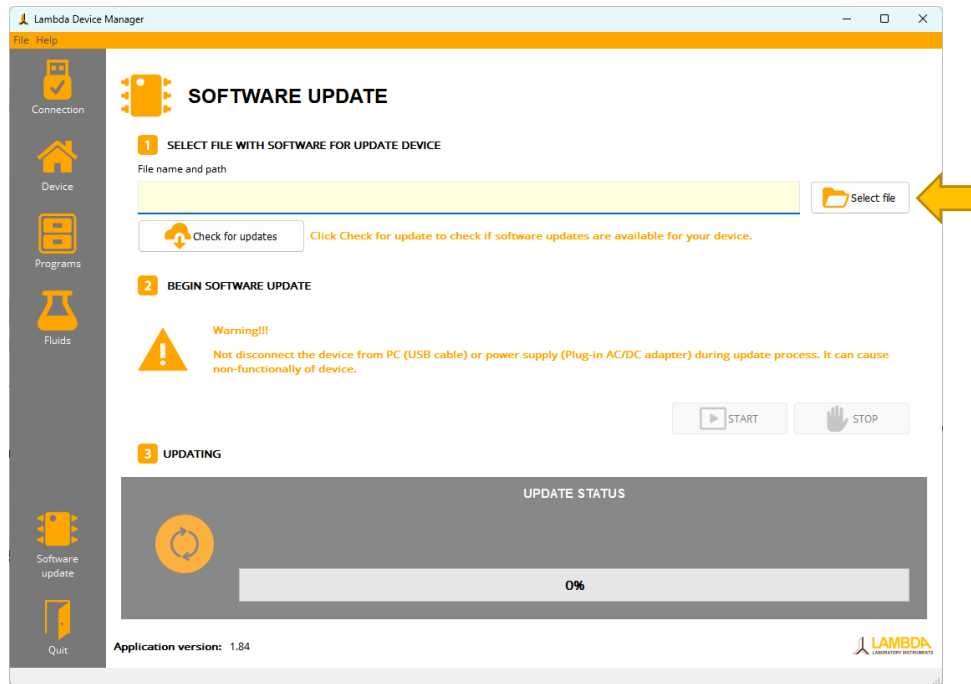

7. Click the **“Select file”** button and browse the path to the decompressed peristaltic pump software file (**pump-2-X.YY.hex**).
8. Click on the **“Start”** button to initiate the update process.



Do not disconnect the power or USB communication cable during the update process!!!

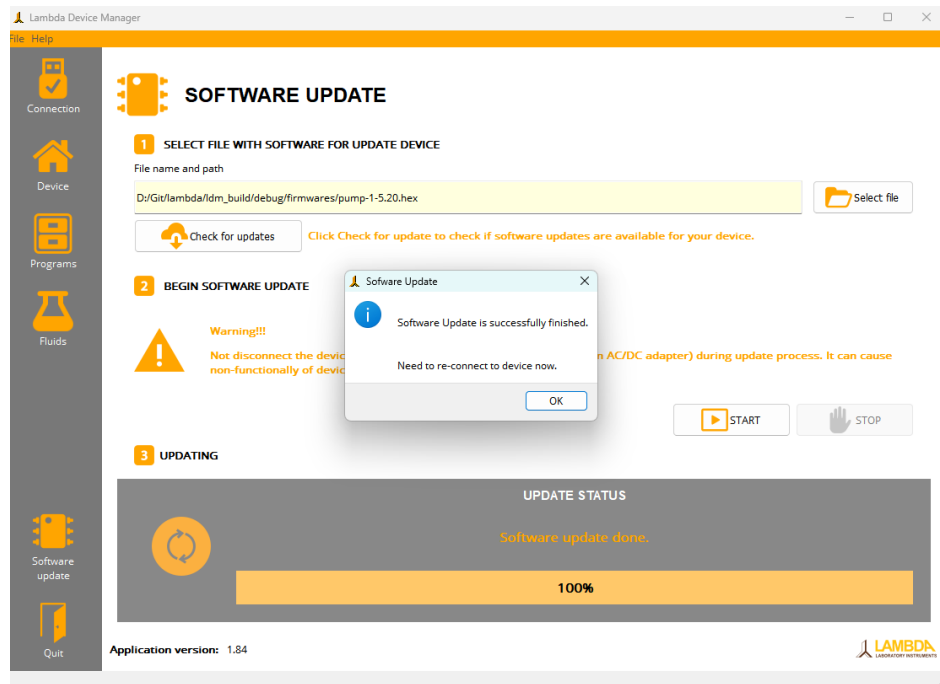

Software update done

9. The progress of the process is displayed in the lower part of the window labelled "**UPDATE STATUS**". Wait for the process to complete. When finished, a new text window will appear: "**Software update is successfully finished.**"
10. Click on the "**OK**" button.

12 USB COMMUNICATION

The peristaltic pump can be set and controlled using a USB interface via a virtual COM port. The communication is text-based and uses the JSON data transfer format. After connecting to a PC, a virtual COM port (COMx) is created automatically. Most operating systems will not require the installation of additional drivers, as the peristaltic pump is identified as a CDC-class device using the USB Descriptor.

Supported data types: number, string, object

12.1 SYNTAX

`{"Cmd":{"GetDeviceInfo":1}}` Each sending is initiated by send character LF (line feed)

Root object is "Cmd".

The internal JSON parser does not respect white spaces in strings. All JSON commands must be cleaned of white space.

Example send command GetDeviceInfo:

```
{"DeviceInfo":{"Name":"Preciflow","DeviceId":3,"SW":"4.19","SerialNumber":3932390,"Type":"Peristalticpump","MaxSpeed":1000,"CalibrationSpeed":500,"SW":4.19,"HW":"120"}}
```

Command returns parameters with values of string/number type (above).

12.2 BASIC COMMANDS

Example: `{"Cmd":{"GetDeviceInfo":1}}`\n

KEY	VALUE	RESPONSE	NOTES
ProcPeriod	Integer	<code>{"ACK":1}</code>	Set the period of sending asynchronously process data (the value of the period is a multiple of 100 ms). Value 0 stop send process data.

KEY	VALUE	RESPONSE	NOTES
SetDefaults	1	{"ACK":1}	Reset configuration to factory defaults.
SetOpMode	0 or 1	{"ACK":1}	Set operating mode (RUN=1, STOP=0)
GetVer	1	Return object Version	
GetProcData	1	Return object ProcData	
GetDeviceInfo	1	Return object DeviceInfo	Information about device
GetConfigData	1	Return object ConfigData	Device setup
ClearError	1	{"ACK":1}	Clear error

12.3 COMMANDS WITH OBJECTS

Example: {"Cmd":{"SetConfigData":{"Speed":100}}}

SUB-OBJECT	KEYS	RESPONSE	DESCRIPTION
SetConfigData	Flow		Flow rate (double) if non-rpm unit is set.
	Speed		Speed in rpm (integer)
	Direction		Rotation (CW 1 or CCW-1)
	FluidName		String max. 32 characters
	Display		Set display brightness (value 0-5)
	Sound	{"ACK":1}	Set sound level (value 0-4)
	Fluids	{"ACK":2}	Enable/disable fluids name bar (0/1)
	Units		0=rpm, 1=ml/h, 2=ml/min, 3=l/h
	Calibration		Calibration constant (0-999.99)
	FlowControl		0=Direct, 1=Program
	FluidName		Current fluid name text max. 32 characters

Receipt of the command is acknowledged by an ACK response with a value of 1. A parameter value that is not valid (e.g., out of range) is an ACK response value of 2.

12.4 RESPONSE OBJECT DESCRIPTION

Example:

```
{"ProcData":{"Flow":1000,"OpMode":0,"DelivTime":61128,"DelivVolume":0.6,"Direction":1,"FluidName":"ACID","FlowUnit":0,"Calibration":200.000}}
```

OBJECT	KEYS	VALUES	VALUE DESCRIPTION
Version	HW	String	Hardware version
	SW	Number	Software version (major.minor)
	SN	Number	Serial number
ProcData	Flow	Number	Flow rate if non-rpm unit is set
	Speed	Number	Speed
	DelivTime	Number	Delivery time in seconds
	DelivVolume	Number	Delivered volume in ml if calibration is set and units are non-rpm
	Direction	Number	CC = 1, CCW = -1
	FluidName	String	Current fluid name set
	FlowUnit	Int	0=RPM, 1=ml/h, 2=ml/min
	Calibration	Number	Flow rate calibration constant
DeviceInfo	Name	String	Device type (Preciflow)
	Deviceld	Number	ID of device
	SW	Number	Software version
	SerialNumber	Number	Device serial number
	Type	String	Device type (Peristaltic pump, ...)
	MaxSpeed	Number	Maximal rpm speed
	CalibrationSpeed	Number	Speed (rpm) used during calibration function
	HW	String	Hardware version
ConfigData	Fluids	Int	Enable/Disable solution names bar on screen
	Display	Int	Display brightness (1-5)
	Sound	Int	Sound level (0-4)
	Units	Int	Current set units type (0=rpm, 1=ml/h, 2=ml/min, 3=l/hr)
	UnitsText	String	Current units text string (only read)

OBJECT	KEYS	VALUES	VALUE DESCRIPTION
	Calibration	Float	Current calibration constant float respect two decimal points – max. 999.99
	FlowControl	Int	0=Direct/1=Program
	FluidName	String	Current fluid name text (max.32 characters)
	Motor	Int	0=smooth, 1=normal (only for PRECIFLOW <i>touch</i> , otherwise return -1)

13 CAN BUS COMMUNICATION (REMOTE 1)

The peristaltic pump implements the CAN Specification 2.0B (Controller Area Network) interface. This asynchronous serial data communication protocol provides reliable communication in an electrically noisy environment.

For internal purposes, the auxiliary bits in the extended identifier are used for the 1x master/n-slave communication model. See below for an explanation.

The pump uses an extended data frame format with a 29-bit identifier. The nominal bit rate is fixed at 1 Mbit/s (cable length is limited to 20m).

13.1 DESCRIPTION OF COMMUNICATION

The CAN bus protocol uses asynchronous communication. Information is passed from the transmitters to receivers in data frames, composed of byte fields that define the contents of the data frame, as illustrated below.

Each frame begins with a Start of Frame (SOF) bit field and ends with an End of Frame (EOF) bit field. The SOF is followed by the Arbitration and Control fields, which specify the message's type, format, length, and priority. This information allows each node on the CAN bus to respond appropriately to the message. The Data field expresses the content of the message and has a variable length of 0 to 8 bytes. Error protection is provided by a Cyclic Redundancy Check (CRC) field and an acknowledgement (ACK) field.

CAN Bus Message Frame

SOF	ARBITRATION	CONTROL	DATA	CRC	ACK	EOF
-----	-------------	---------	------	-----	-----	-----

13.1.1 EXTENDED DATA FRAME

The extended data frame begins with an SOF bit followed by a 31-bit arbitration field, as shown below. The arbitration field for the extended data frame contains 29 identifier bits in two fields, separated by a Substitute Remote Request (SRR) bit and an IDE bit. The SRR bit determines whether the message is a remote frame. SRR is 1 for

extended data frames. The IDE bit indicates the data frame type. IDE is 1 for the extended data frame. The extended data frame Control field consists of seven bits. The first bit is the RTR. For the extended data frame, RTR is 0. The next two bits, RB1 and RB0, are reserved bits in the dominant state (logic level '0'). The last four bits in the control field are the DLC, which indicates the number of data bytes in the message. The control field is followed by the data field. This field contains the message data – the actual payload of the data frame. This field is of variable length, ranging from 0-8 bytes. The number of bytes is user-selectable. The data field is followed by the CRC field, which is a 15-bit CRC sequence with a delimiter bit. The Acknowledgement (ACK) field is sent as a recessive bit (logic level '1') and is overwritten as a dominant bit by any receiver that has correctly received the data. The message is acknowledged by the receiver regardless of the result of the acceptance filter comparison. The last field is the EOF field, which consists of seven recessive bits that indicate the end of the message.

Format of the Extended Data Frame (29-Bit identifier)

S O F	IDENTIFIER	S R R	I D E	IDENTIFIER	R T R	R1 1	R0 0	DLC 4 bits	DATA 8 bytes	CRC 16 bits	ACK 2 bits	EOF 7 bits	IFS 3 bits
	11-bit			18-bit									

An extended identifier is used to identify the peristaltic pump on the network. 29 bits are used to distinguish master/slave messages (frames) and to transmit a serial number that uniquely identifies the pump on the network (more in chapter 13.1.2).

After the pump is connected to the CAN network, the pump transmits the CAN_STATUS command (*chapter 13.3*) until the message is acknowledged by any receiver, regardless of the result of the acceptance filter comparison.

Once the CAN_STATUS message is acknowledged, the peristaltic pump automatically triggers the asynchronous transmission of the following commands outside CAN_STATUS:

- CAN_DEV_NAME
- CAN_FLOW
- CAN_FLUID_NAME

- CAN_PURPOSE
- CAN_ROTATION

It sends these commands periodically, approximately every 50 milliseconds.

(For more information about commands, see Chapter 13.3)

13.1.2 EID BITWISE SIGNIFICANCE

The extended data frame is composed as follows. Serial number 3932390₁₀ is used for the following examples.

EID assembled for broadcasting (the pump sends, master receives)

EID (29 bits)			
Slave identifier		None (no significance)	Pump Serial Number
Bit 28 1	Bit 27 1	Bit 26	Bit 25 – Bit 0
0x1800 0000			0x3FF FFFF e.g. (0x183C00E6 [bitwise AND] 0x3FF FFFF -> 0x3C00E6 = 3932390 ₁₀)
0x1800 000 (bitwise OR) 0x3C00E6			
 0x183C00E6			

EID assembled for receiving (master transmits)

EID (29 bits)			
Slave identifier		None (no significance)	Pump Serial Number
Bit 28 0	Bit 27 1	Bit 26	Bit 25 – Bit 0
0x0800 0000			3932390 ₁₀ = 0x3C00E6
0x0800 0000 (bitwise OR) 0x3C00E6			
 0x083C00E6			

EID decomposed into SID and EID for arbitration fields (master sends)

EID (29 bits) – 0x083C00E6	
SID (11 bits)	EID (18 bits)
010 0000 1111	00 0000 0000 1110 0110
0x20F	0xE6
0x083C00E6 >> 18	0x083C00E6 bitwise AND 0x3FFFF
(shift the requested EID 18 bits to the right)	Perform bitwise AND with EID and 0x3FFFF

13.2 MESSAGE FILTERING

The peristaltic pump continuously monitors messages on the CAN bus. As messages are received, the message identifier (EID) is compared to the filter/mask. If there is a match, the pump processes the message (frame). The first byte of the CAN message/frame is reserved to identify the command to be executed by the peristaltic pump or, when transmitting to a master device, to identify the data it is sending. The remaining bytes (up to 7) are reserved for the actual message data.

In order to accept the message, an EID (29-bits) must be created in the format described below.

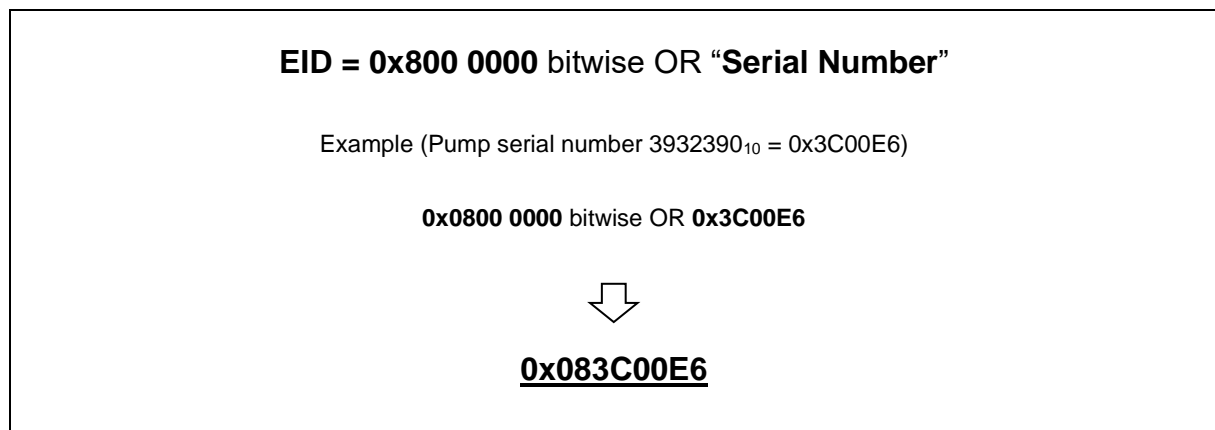

If you use, for example, a 32-bit integer to compose the EID, you need to clean it up using bitwise AND 0x1FFFFFFF.

13.3 COMMANDS (PSEUDO-IDENTIFIER)

The commands (pseudo-identifiers) are used to identify the type of message that the peristaltic pump is sending or that the pump is to process. Commands sent to the pump (EID bit 28 = 0 and 27 = 1) may or may not contain values. Some commands contain only the command code in the data portion of the message. A command that contains a value must be processed back to the correct state.

The EID must be constructed correctly to send a message to the pump (see chapter 13.1.2).

Commands are identified by the code (value) of the first data byte of the CAN message (frame). The following bytes represent the data value of the parameter. The following data bytes (max. 7) represent the data value of the command.

EXAMPLE (READ)

CAN_STATUS message sent by pump with serial number 3932390₁₀.

Message/Frame:

EID	DLC	DATA0 (command code)	DATA1	DATA2	DATA3	DATA4	DATA5	DATA6	CRC
0x183C00E6	0x7	0x80	0x03	0x00	0x00	0x04	0x1B	0x78	0x717A

Extracting the serial number from the EID identifier (hexadecimal):

0x183C00E6 bitwise AND 0x3FFFFFFF = 0x3C00E6 (**3932390**₁₀)

Command Type

DATA0 = 0x80 -> CAN_STATUS

Command Data

DATA1 = 0x03 -> Peristaltic pump Preciflow

DATA2 = 0x00 -> STOP operating mode

DATA3 = 0x00 -> No error

DATA4 = 0x04 -> Software version (**major**.minor) -> 0x04.xx (**4 decimal**)

DATA5 = 0x1B -> Software version (major.**minor**) -> x.0x1B (**27 decimal**)

DATA6 = 0x78 -> Hardware version 0x78 -> **120 decimal**)

EXAMPLE (WRITE)

CAN_FLOW command to set pump speed to 1000 rpm with serial number 3932390₁₀.

EID	DLC	DATA0 (command code)	DATA1	DATA2	DATA3	DATA4
0x083C00E6	0x8	0x82	0x00	0x00	0x7A	0x44

For more information on how to represent each data type, see 13.3.3.

13.3.1 READ COMMANDS

The table lists the commands the pump sends and describes the information they provide. Some commands are sent asynchronously, see section (13.1). Only the meaning of the data part of the CAN message (frame) is described in the table. The whole message is described above.

COMMAND NAME	CODE (1 st data byte)	DATA LENGTH (bytes)	DESCRIPTION (DATA1-DATA7)	
			Byte order	Byte (value) significance
CAN_STATUS	0x80	7	0	Command identifier
			1	Device type 0x03 = PRECIFLOW 0x05 = HIFLOW 0x06 = MAXIFLOW 0x07 = MEGAFLOW
			2	Operating mode 0x00 = STOP (LOCAL) 0x01 = RUN (LOCAL) 0x02 = ALARM (LOCAL) 0x03 = REMOTE
			3	Error code 0 = no error 0x01 = ERR_IMAX_OVER 0x02 = ERR_PWM_OVER 0x03 = ERR_IMAX_F_OVER 0x04 = ERR_IMF_LIM_OVER 0x05 = ERR_MOT_STALL 0x06 = ERR_LID_OPEN 0x10 = ERR_PROG_END
			4	Software version (major, e.g. 4 ₁₀)
			5	Software version (minor, e.g. 26 ₁₀)
			6	Hardware version (e.g. 120 ₁₀)
			e.g. 0x80 0x03 0x00 0x00 0x04 0x1B 0x78	
CAN_FLOW	0x82	5	0	Command identifier
			1-4	Double data type Current set flow in rpm units
			e.g. 1000 rpm 0x82 0x00 0x00 0x7A 0x43	
CAN_ROTATION	0x88	5	0	Command identifier
			1-4	Integer data type Current set direction of rotor rotation 0x00000001 = CW 0xFFFFFFFF = CCW
			e.g. 0x88 0x00 0x00 0x00 0x01	
CAN_DEV_NAME	0x81	0 – 8 (max 4x 8 bytes)	0	Command identifier
			1-7	String data type Name of device (e.g. MegafLOW)
			e.g. 0x81 0x50 0x72 0x65 0x63 0x69 0x66 0x6C 0x81 0x6f 0x77 0x00	

For information about the data format, see the chapter 13.3.3.

13.3.2 WRITE COMMANDS

The table contains commands that can be used to control the pump or change parameter values. Only the commands, i.e., the data part of the CAN message, are described in the table. Creating a complete CAN message/frame is necessary for writing, as described in chapter 13.1.1.

COMMAND NAME	CODE (1 st data byte)	DATA LENGTH (bytes)	DESCRIPTION	
			Byte order	Byte (value) significance
CAN_FLOW	0x82	5	0	Command identifier
			1-4	Double data type Current set flow in rpm units
			e.g. 1000 rpm 0x82 0x00 0x00 0x00 0x7A 0x44	
CAN_ROTATION	0x88	5	0	Command identifier
			1-4	Integer data type Current set direction of rotor rotation 0x00000001 = CW 0xFFFFFFFF = CCW
			e.g. 0x88 0x00 0x00 0x00 0x01	
CAN_FLUID_NAME	0x86	0 – 8 (max 4x 8 bytes)	0	Command identifier
			1-7	String data type Fluid name (e.g. BASE)
CAN_LOCATION	0x89	5	0	Command identifier
			1-4	Integer data type 0x01 = calls up the location function (display flashes)
			e.g. 0x89 0x00 0x00 0x00 0x01	
CAN_PURPOSE	0x8A	5	0	Command identifier
			1-4	Integer data type 0x00 = None 0x01 = ACID 0x02 = BASE 0x03 = FOAM 0x04 = FEED 0x05 = HARVEST 0x06 = PUMP-X 0x07 = PUMP-Y 0x08 = PUMP-Z
			e.g. 0x8A 0x00 0x00 0x00 0x01	
CAN_MASTER	0x8C	1	0	Command identifier
			e.g. 0x8C	
CAN_CLEAR_ERROR	0x8B	1	0	Command identifier
			e.g. 0x8B	

For information about the data format, see the chapter 13.3.3.

13.3.3 DATA FORMAT

- Integer - 32-bit signed integer, in little-endian format with the Least Significant byte (LSB) at lower data byte (DATA1).

EXAMPLE, READ

EID	DLC	DATA0 (command code)	DATA1	DATA2	DATA3	DATA4
0x183C00E6	0x05	0x88	0x00	0x00	0x00	0x01

Result: 0x00000001 = 1₁₀

EXAMPLE, WRITE

EID	DLC	DATA0 (command code)	DATA1	DATA2	DATA3	DATA4
0x083C00E6	0x05	0x88	0xFF	0xFF	0xFF	0xFF

Change rotation (-1)

- Double (IEEE 754 floating point format, single-precision, 32bit) – values are represented in little-endian format with the Least Significant byte (LSB) at lower data byte (DATA1).

EXAMPLE, READ (CAN_FLOW)

EID	DLC	DATA0 (command code)	DATA1	DATA2	DATA3	DATA4
0x183C00E6	0x5	0x88	0x00	0x00	0x20	0x41

Result: 0x41200000 = 10₁₀ rpm

EXAMPLE, WRITE (CAN_FLOW)

EID	DLC	DATA0 (command code)	DATA1	DATA2	DATA3	DATA4
0x083C00E6	0x5	0x88	0x00	0x00	0x20	0x41

Result: 0x41200000 = 10₁₀ rpm

- Strings (ASCII characters)

Strings are represented as byte arrays (hexadecimal values of ASCII characters).

The maximum length of characters is limited to 32. The end of string is identified by byte **0x00**. The user application must ensure the creation of a chain based on the processing of up to 4 messages.

EXAMPLE, READ (CAN_DEV_NAME) – 1st message

EID	DLC	DATA0 (command code)	DATA1	DATA2	DATA3	DATA4	DATA5	DATA6	DATA7
0x183C00E6	0x8	0x81	0x50	0x72	0x65	0x63	0x69	0x66	0x6C

Result: 0x50 = 'P', 0x72 = 'r', 0x65 = 'e', 0x63 = 'c'; 0x69 = 'i', 0x66 = 'f', 0x6C = 'l'

EXAMPLE, READ (CAN_DEV_NAME) – 2nd message

EID	DLC	DATA0 (command code)	DATA1	DATA2	DATA3	DATA4	DATA5	DATA6	DATA7
0x183C00E6	0x8	0x81	0x6f	0x77	0x00				

Result: 0x6f = 'o', 0x77 = 'w', 0x00 = end

Final string = **Preciflow**

13.4 HEARTBEAT

Peristaltic pumps must accept the CAN_MASTER command to remain in REMOTE mode. If the peristaltic pump loses the connection, i.e., stops receiving this command, the motor automatically stops, and the pump switches from REMOTE mode to STOP mode (local control).

This method ensures that the peristaltic pump stops dosing the moment it loses contact with the element that controls it.

The limit for receiving the CAN_MASTER command is 15x the asynchronous transmission period (50 ms), i.e., approximately 750 milliseconds.

13.5 CONNECTOR WIRING

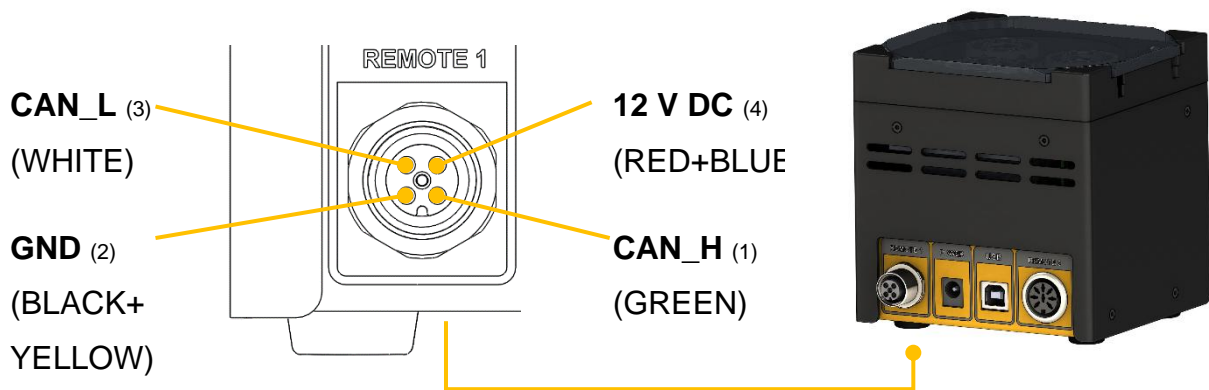

Marking	Color	Purpose
CAN_L	White	CAN-
CAN_H	Green	CAN+
GND	Black+Yellow	Ground (Device power supply)
12V DC	Red+Blue	Device power supply It is used to power the entire device instead of using an external power adapter. (If a power adapter is connected to the device, the voltage will also be present on this pin).



- The input voltage must not exceed 14V, the absolute maximum of 16V
- Take extra care not to reverse the polarity of 12V and GND

14 REMOTE 2 CONNECTOR FUNCTIONALITY

14.1 CONNECTOR WIRING

No.	Colour	Description
1	yellow	(+) input remote speed control 0-10V *)
2	grey	step signal from motor (0 and 12V)
3	green	earth, 0 V
4	brown	+ 12 V
5	white	(+) input remote ON/OFF; 0V = ON, 3–12 V = OFF
6	pink	earth, ground (GND)
7	red	RS 485 B (-)
8	blue	RS 485 A (+)

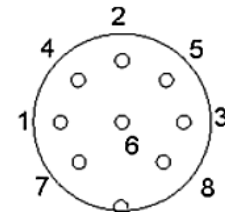

Figure 9-1 8-pole connector

*) (zero line connected to the contact no. 3)

14.2 RS COMMUNICATION PROTOCOL

14.2.1 FORMAT OF DATA SENT BY THE PC TO THE PUMP AND BACK

Data sent by the PC: #ss mm a ddd qs c

Data sent back by the pump: <mm ss a ddd qs c

where,

- #** is the first sign of a command sent by PC
- <** is the first sign of a message sent by pump
- ss** is the address of the pump
- mm** is the address of the PC
- a** is the command for the sense of rotation:
- r** for clockwise (cw) rotation (to the right)
- l** for counter-clockwise (ccw) rotation (to the left)

- ddd** is the speed of rotation (3 ASCII numbers from 0 to 9; sent from the highest order digit to the lowest order digit)
- qs** is the control sum in HEX format (2 ASCII signs of the type 0...9ABCDEF)
- c** is the end sign cr (carriage return) The pump will fulfill the task and block any manual command on the pump front panel.

14.2.2 COMMANDS NOT CONTAINING DATA

- # ss mm **g** qs c activates the local command of the pump
- # ss mm **s** qs c the pump is stopped
- # ss mm **G** qs c to send pump data to the PC

14.2.3 CHECKSUM CONTROL

The PC sends: #0201r123EEcr

The control sum (checksum) qs is made in the following way (only the last byte (2 ASCII characters of the type 0...9ABCDEF) is taken):

#	0	2	0	1	r	1	2	3	EE (last byte)	cr
23h	+30h	+32h	+30h	+31h	+72h	+31h	+32h	+33h	=1EEh	0Dh

14.2.4 FORMAT OF THE DATA TRANSMISSION

Speed: 2400 Bd (Baud)
8 data bits, odd parity, 1 stop bit

These settings are for backward compatibility with previous generation devices.

14.2.5 EXAMPLES

Address of the PC: 01
Address of the pump: 02

The PC sends: #0201r123EEcr
The pump will rotate cw at the speed of 123

The PC sends: #0201G2Dcr
The answer of the pump: <0102r12307cr

The PC sends: #0201l123E8cr
The pump will rotate ccw at the speed of 123.

The PC sends: #0201s59cr

The pump stops.

The PC sends: #0201g4Dcr

The pump will go to the local command (pump front panel is activated).

15 LIST OF ACCESSORIES

- 800113 Stainless steel tubing clamp

Tubing for LAMBDA PRECIFLOW *touch*, HiFLOW *touch* & MAXIFLOW *touch*:

(Article number, material, inner diameter/outer diameter, length)

- 4815-1 Silicone tubing 0.5/2.5 mm x 10 m
- 4815-2 Silicone tubing 1/3 mm x 10 m
- 4815-3 Silicone tubing 2/4 mm x 10 m
- **4815-4 Silicone tubing 3/5 mm x 10 m**
- 4815-5 Silicone tubing 4/6 mm x 10 m
- 4815-3v Viton tubing 2/4 mm x 5 m
- 4815-4v Viton tubing 3/5 mm x 5 m

Tubing for LAMBDA MEGAFLOW *touch*:

(Article number, material, inner diameter/outer diameter, length)

- 800100-26-25m Silicone tubing 2/6 mm x 25 m
- **800100-48-25m Silicone tubing 4/8 mm x 25 m**
- 800100-610-25m Silicone tubing 6/10 mm x 25 m
- 800100-812-25m Silicone tubing 8/12 mm x 25 m

